

FEATURES

- VOLTAGE: 20 TO 100 VOLTS, CURRENT: 1.0 & 2.0 AMPERE
- FLAT PACK - LOW PROFILE, FOR SURFACE MOUNT APPLICATIONS
- FAST RESPONSE AND LOW FORWARD VOLTAGE
- HIGH TEMPERATURE SOLDERING (250°C/10 SECONDS)
- EASY PICK AND PLACE

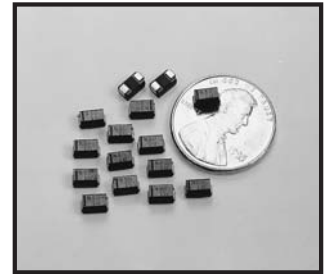

RoHS Compliant

includes all homogeneous materials

*See Part Number System for Details

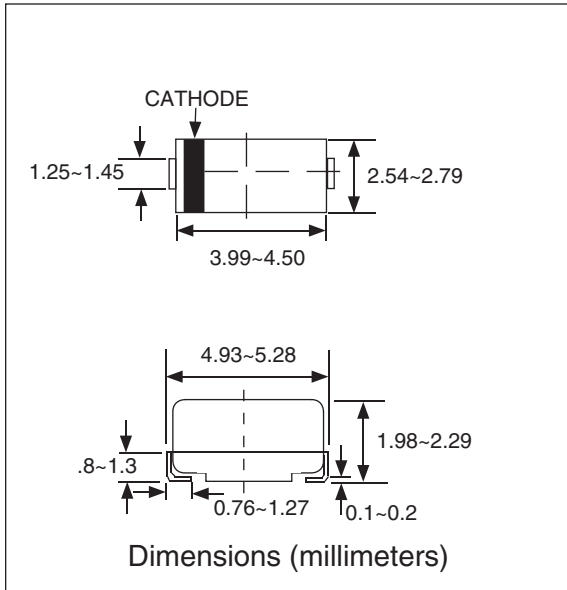

MECHANICAL DATA:

SIZE: SMA/DO-214AC

CASE: Molded epoxy

TERMINALS: Solder plated Copper alloy

POLARITY: Indicated by cathode band

STANDARD PACKAGING: 12mm tape (EIA-RS-481)

WEIGHT: 0.064 gram

PART NUMBERING SYSTEM

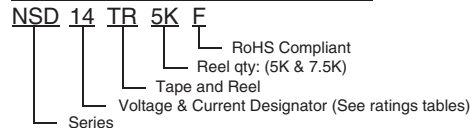

MAXIMUM RATINGS (At $T_A=25^\circ\text{C}$ unless otherwise noted)

Ratings	Symbol	NSD12	NSD13	NSD14	NSD15	NSD16	NSD18	NSD19	NSD100	UNITS
Maximum Recurrent Peak Reverse Voltage	VRRM	20	30	40	50	60	80	90	100	Volts
Maximum RMS Voltage	VRMS	14	21	28	35	42	56	64	71	Volts
Maximum DC Blocking Voltage	VDC	20	30	40	50	60	80	90	100	Volts
Maximum Average Forward Rectified Current	I_o	1.0								Amps
Peak Forward Surge Current 8.3ms single half sine-wave superimposed on rated load (JEDEC method)	IFSM	30								Amps
Maximum Thermal Resistance	(Note 2) RqJL	25								$^\circ\text{C/W}$
Typical Junction Capacitance (Note 1)	CJ	110			80		70			pF
Operating and Storage Temperature Range	TJ, TSTG	-55 ~ +150								$^\circ\text{C}$
Typical Reverse Recovery Time	TRR	15								nS

ELECTRICAL CHARACTERISTICS (At $T_A=25^\circ\text{C}$ unless otherwise noted)

Characteristics	Symbol	NSD12	NSD13	NSD14	NSD15	NSD16	NSD18	NSD19	NSD100	UNITS	
Maximum Forward Voltage at 1.0A DC	VF	0.50			0.65		0.85			Volts	
Maximum DC Reverse Current at Rated DC Blocking Voltage (Note 3)	IR	@ $T_A=25^\circ\text{C}$				0.5					mAmps
		@ $T_A=100^\circ\text{C}$				10.0					mAmps

- NOTES:
1. Measured at 1.0MHz and applied average voltage of 4.0VDC.
 2. Thermal resistance junction to terminal, 5mm^2 (0.013 mm Thick) copper land patterns.
 3. Pulse width 300uS, 2% duty cycle.

RATING AND CHARACTERISTIC CURVES (NSD12 THRU NSD100)

FIG. 1 - FORWARD CURRENT DERATING CURVE

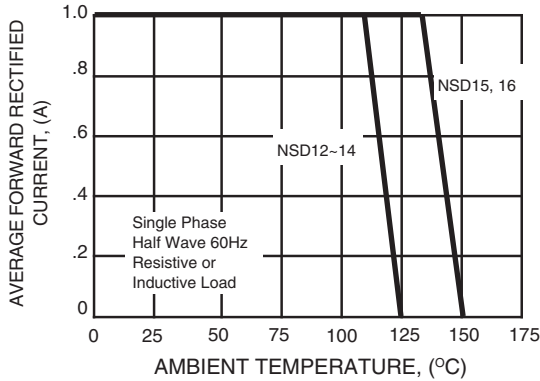
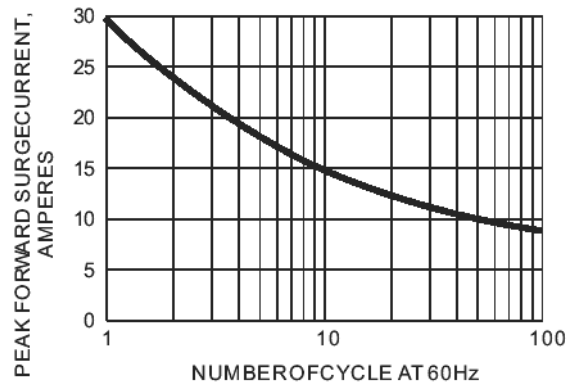
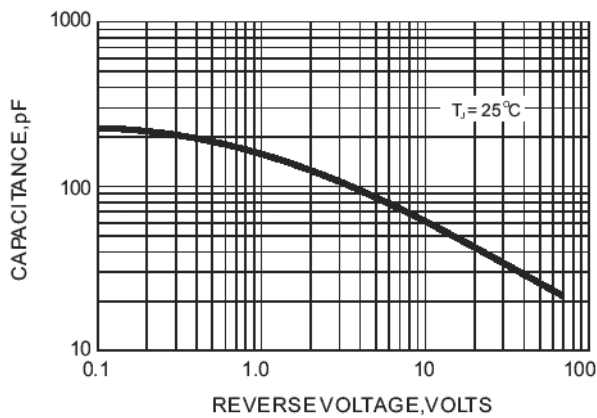
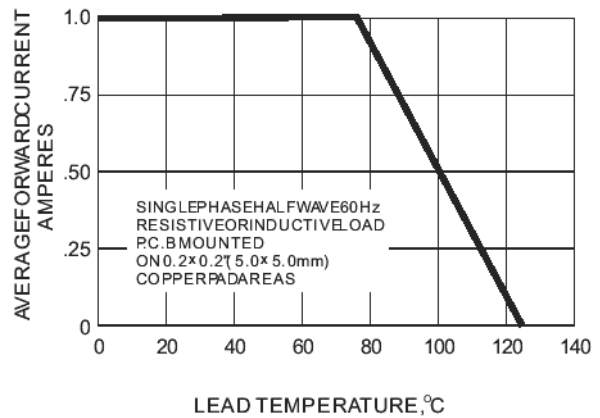
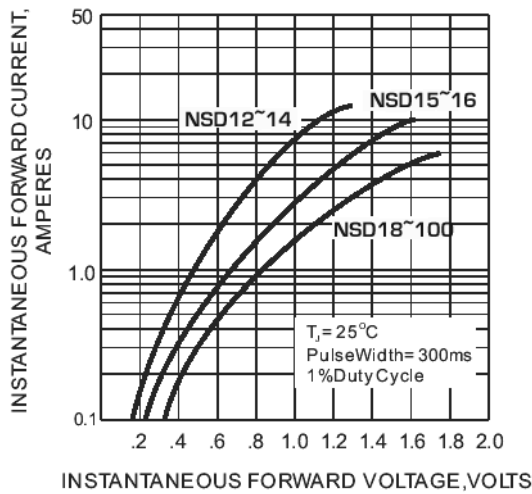
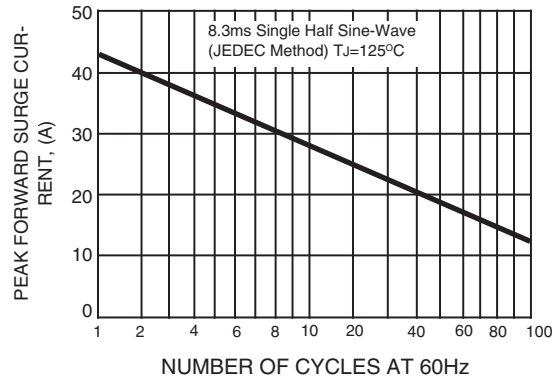

FIG. 2 - MAXIMUM NON-REPETITIVE FORWARD SURGE CURRENT



MAXIMUM RATINGS (At $T_A=25^\circ\text{C}$ unless otherwise noted)

Ratings	Symbol	NSD22	NSD23	NSD24	NSD25	NSD26	UNITS
Maximum Recurrent Peak Reverse Voltage	VRRM	20	30	40	50	60	Volts
Maximum RMS Voltage	VRMS	14	21	28	35	42	Volts
Maximum DC Blocking Voltage	VDC	20	30	40	50	60	Volts
Maximum Average Forward Rectified Current	I_o	2.0					Amps
Peak Forward Surge Current 8.3 ms single half sine-wave superimposed on rated load (JEDEC method)	IFSM	50					Amps
Typical Thermal Resistance	R_{th-JA} R_{th-JL}	75.0 17.0					$^\circ\text{C/W}$
Typical Junction Capacitance (Note 1)	CJ	220			180		pF
Operating and Storage Temperature Range	TJ/TSTG	-65 to +125/-65 to +150			-65 to +150		$^\circ\text{C}$

ELECTRICAL CHARACTERISTICS (At $T_A=25^\circ\text{C}$ unless otherwise noted)

Characteristics	Symbol	NSD22	NSD23	NSD24	NSD25	NSD26	UNITS
Maximum Forward Voltage at 2.0A DC	VF	0.50			0.70		Volts
Maximum DC Reverse Current at Rated DC Blocking Voltage	IR	0.5					mAmps
		20.0			10.0		mAmps

NOTE: 1. Measured at 1.0 MHz and applied average voltage of 4.0VDC.

Fig. 1 - Derated Curve for Output Rectifier Current

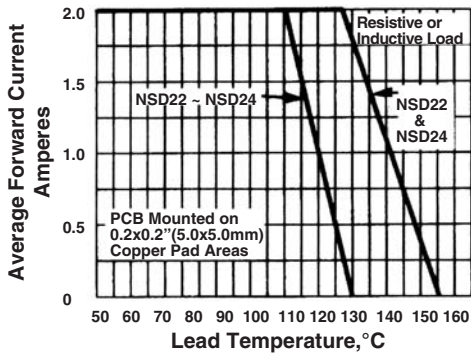

Fig. 2 - Typical Junction Capacitance

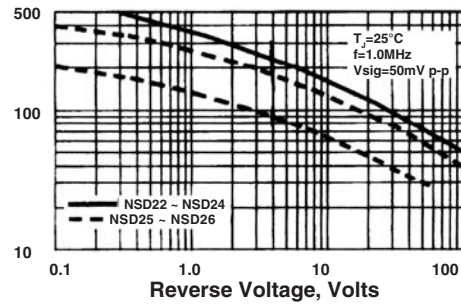

Fig. 3 - Typical Reverse Current Characteristics

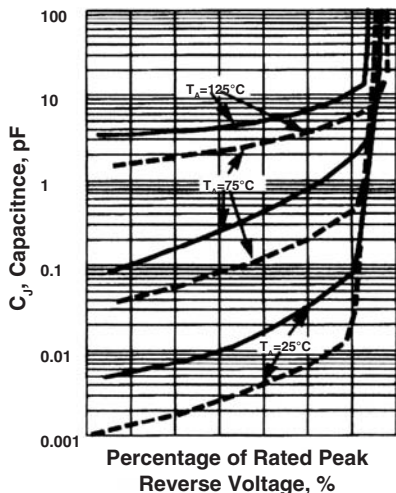

Fig. 4 - Maximum Non-Repetitive Peak Forward Surge Current

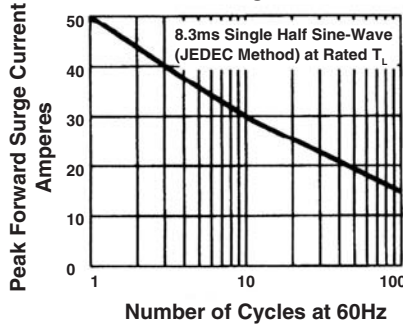
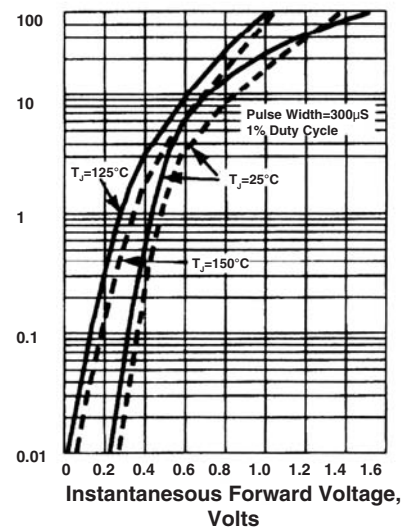

Fig. 5 - Typical Instantaneous Forward Characteristics



MAXIMUM RATINGS (At $T_A=25^\circ\text{C}$ unless otherwise noted)

Ratings	Symbol	NSD32	NSD33	NSD34	NSD35	NSD36	UNITS
Maximum Recurrent Peak Reverse Voltage	VRRM	20	30	40	50	60	Volts
Maximum RMS Voltage	VRMS	14	21	28	35	42	Volts
Maximum DC Blocking Voltage	VDC	20	30	40	50	60	Volts
Maximum Average Forward Rectified Current	I_o	3.0					Amps
Peak Forward Surge Current 8.3 ms single half sine-wave superimposed on rated load (JEDEC method)	IFSM	80					Amps
Typical Thermal Resistance	Rth-JA Rth-JL	55.0 17.0					$^\circ\text{C}/\text{W}$
Typical Junction Capacitance (Note 1)	CJ						pF
Operating and Storage Temperature Range	TJ/TSTG	-55 to +125/-55 to +150		-55 to +150			$^\circ\text{C}$

ELECTRICAL CHARACTERISTICS (At $T_A=25^\circ\text{C}$ unless otherwise noted)

Characteristics	Symbol	NSD32	NSD33	NSD34	NSD35	NSD36	UNITS
Maximum Forward Voltage at 3.0A DC	VF	0.50			0.60		Volts
Maximum DC Reverse Current at	IR	0.5			10.0		mAmps
Rated DC Blocking Voltage							
	@ $T_A=100^\circ\text{C}$	20.0			10.0		mAmps

NOTE: 1. Measured at 1.0 MHz and applied average voltage of 4.0VDC.

Fig. 1 - Derated Curve for Output Rectifier Current

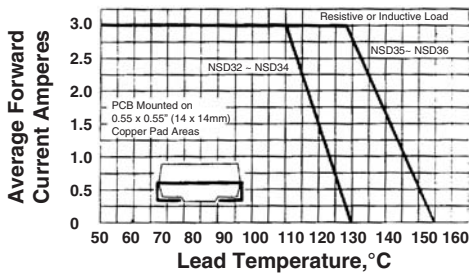

Fig. 2 - Maximum Non-Repetitive Peak Forward Surge Current

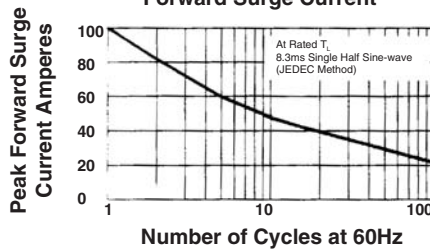

Fig. 3 - Typical Junction Capacitance

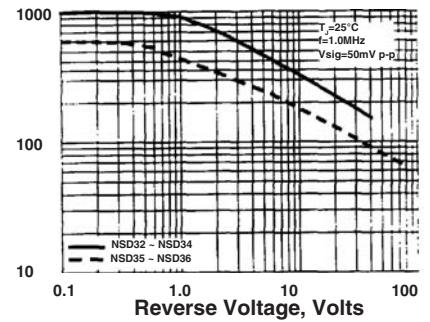

Fig. 4 - Typical Instantaneous Forward Characteristics

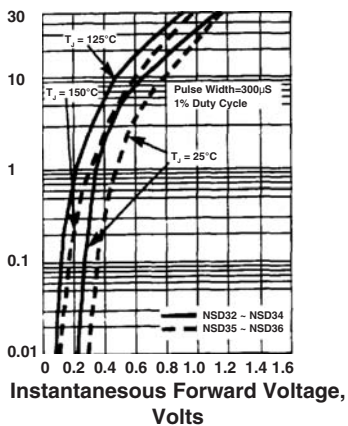

Fig. 5 - Typical Reverse Current Characteristics

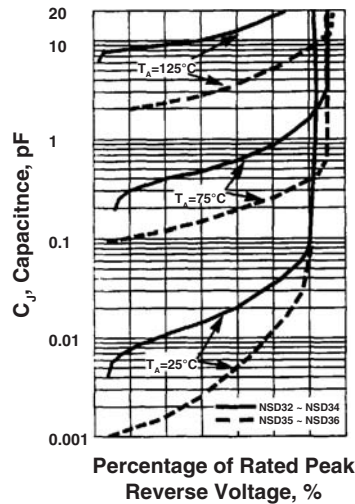
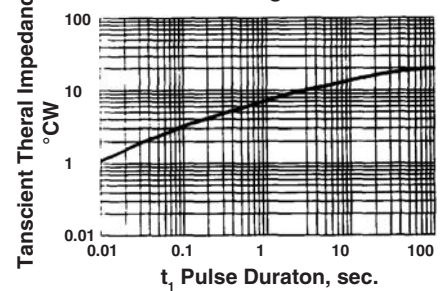
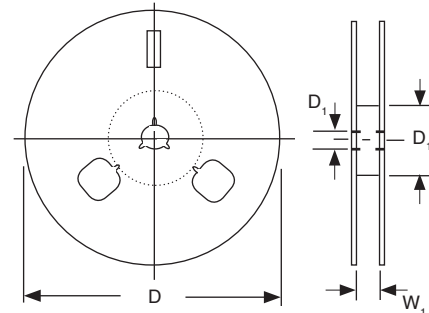
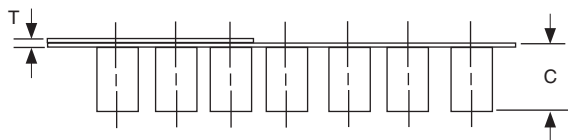
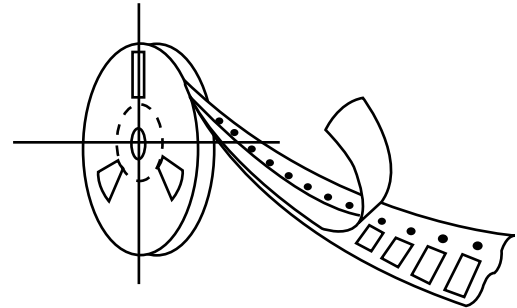
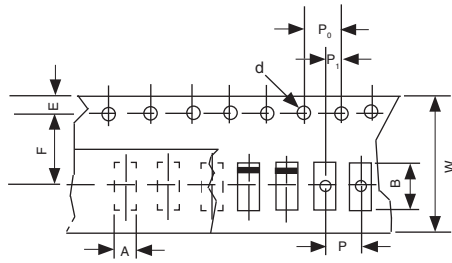

Fig. 6 - Maximum Non-Repetitive Peak Forward Surge Current



TAPING AND MOUNTING SPECIFICATIONS



RECOMMENDED LAND PATTERN

REEL QUANTITIES

Reel Size	Reel Quantity
13 inch (330mm)	5,000 & 7,500 pcs



Dimensions	(mm)
A	1.2-1.8
B	1.5-2.2
C	2.7 max.

Item	Symbol	Specifications (mm)	Specifications (inch)
Carrier Width	A	3.2 max.	.126 max.
Carrier Length	B	7.8 max.	.307 max.
Carrier Depth	C	4.5 max.	.177 max.
Sprocket Hole	d	1.5 ± 0.1	.059 ± .004
Reel Outside Diameter	D	178 ± 2.0	7.00 ± .079
Reel Inner Diameter	D ₁	50 min.	1.969 min.
Feed Hole Diameter	D ₂	13.0 ± 0.5	.512 ± .020
Sprocket Hole Position	E	1.75 ± 0.1	.069 ± .004
Punch Hole Position	F	5.5 ± 0.1	.217 ± .004
Punch Hole Pitch	P	4.0 ± 0.1	.157 ± .004
Sprocket Hole Pitch	P ₀	4.0 ± 0.1	.157 ± .004
Embossment Center	P ₁	2.0 ± 0.05	.079 ± .002
Overall Tape Thickness	T	1.1 max.	.043 max.
Tape Width	W	12.0 ± 0.3	.472 ± .012
Reel Width	W ₁	18.4 max.	.724 max.

NOTE: Devices are packed in accordance with EIA standard RS-481-A and specifications given above.