



actual size

# Oscillator JO11 · 1.8 V ~ 3.3 V

- SMD Oscillator with Stop Function · 1.6 x 1.2 mm
- LVCMOS / HCMOS compatible output
- Variable supply voltage 1.8 V ~ 3.3 V
- Very low current consumption
- Seam sealed ceramic/metal package



RoHS compliant



Pb free



REACH compliant



Conflict mineral free

## GENERAL DATA

TYPE		JO11 1.8 V ~ 3.3 V
frequency range		5.0 ~ 60.0 MHz (15 pF max.)
frequency stability over all*		± 25 ppm ~ ± 100 ppm (see table 1)
current consumption		see table 2
supply voltage $V_{DC}$		1.8 V -10% ~ 3.3 +10% variable
temperature	operating	-20 °C ~ +70 °C up to -40 °C ~ +125 °C (table 1)
	storage	-55 °C ~ +125 °C
output	rise & fall time	6 ns max. (1.8 V) / 5 ns max. ( $\geq$ 2.5 V)
	load max.	15 pF
	current max.	4.0 mA
	low level max.	0.4 V
	high level min.	$V_{DC} - 0.4$ V
output enable time max. / typ.		5 ms / 1 ms
output disable time max.		200 ns
start-up time max. / typ.		5 ms / 0.5 ms ( $t_0$ when $V_{DC} > 1.62$ V)
standby function		stop
standby current max. / typ.		10 $\mu$ A (T1) & 20 $\mu$ A (T2, T3) / 1 $\mu$ A
phase jitter 12 kHz ~ 20.0 MHz		< 1.0 ps RMS
symmetry at $0.5 \times V_{DC}$		45% ~ 55% max. (ref. +25 °C)

note: rise time: 0.1 VDC ~ 0.9 VDC / fall time: 0.9 VDC ~ 0.1 VDC

## TABLE 1: FREQUENCY STABILITY CODE

stability code		A	B	G	C
		± 100 ppm	±50 ppm	± 30 ppm	± 25 ppm
-20 °C ~ +70 °C		○	○	○	○
-40 °C ~ +85 °C	T1	○	○	○	
-40 °C ~ +105 °C	T2	○	○		
-40 °C ~ +125 °C	T3	○			

○ available

\* includes stability at 25 °C, operating temp. range, supply voltage change, shock and vibration, aging 1st year.

## TABLE 2: CURRENT CONSUMPTION MAX.

Supply current max.	load	1.8 V	2.5 V	3.3 V
1.0 ~ 9.9 MHz	15 pF	1.0 mA	1.3 mA	2.0 mA
10.0 ~ 19.9 MHz	15 pF	1.6 mA	2.0 mA	3.0 mA
20.0 ~ 29.9 MHz	15 pF	2.2 mA	3.0 mA	4.0 mA
30.0 ~ 39.9 MHz	15 pF	2.5 mA	3.5 mA	5.0 mA
40.0 ~ 50.0 MHz	15 pF	3.0 mA	4.5 mA	6.0 mA

note: please also refer to I/V plots showing typical supply current at 5pF / 10pF / 15pF

## DIMENSIONS

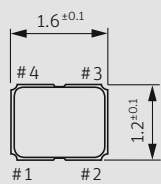

top view

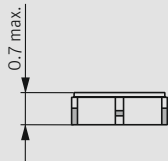

side view

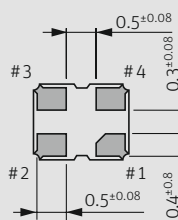

bottom view

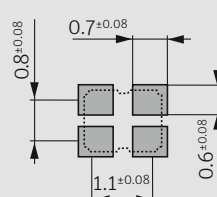

pad layout

# 1: e/d  
# 2: ground  
# 3: output  
# 4:  $V_{DC}$

in mm

## ORDER INFORMATION

0	frequency	type	frequency stability code	supply voltage code	output load code	option
Oscillator	5.0 ~ 60.0 MHz	JO11	see table 1	1V3 = 1.8 V ~ 3.3 V	1 = 15 pF	blank = -20 °C ~ +70 °C T1 = -40 °C ~ +85 °C T2 = -40 °C ~ +105 °C T3 = -40 °C ~ +125 °C

Example: 0 20.0-JO11-G-1V3-1-T1-LF (Suffix LF = RoHS compliant / Pb free)

# Oscillator J011 · 1.8 V ~ 3.3 V · Stop Function

SUPPLY CURRENT VS.  $V_{CC}$  AT DIFFERENT FREQUENCIES;  $CL = 5$  PF

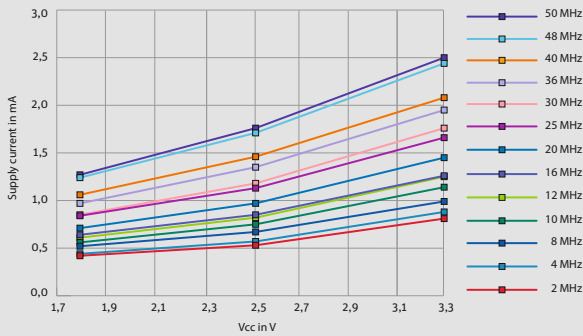

SUPPLY CURRENT VS.  $V_{CC}$  AT DIFFERENT FREQUENCIES;  $CL = 10$  PF

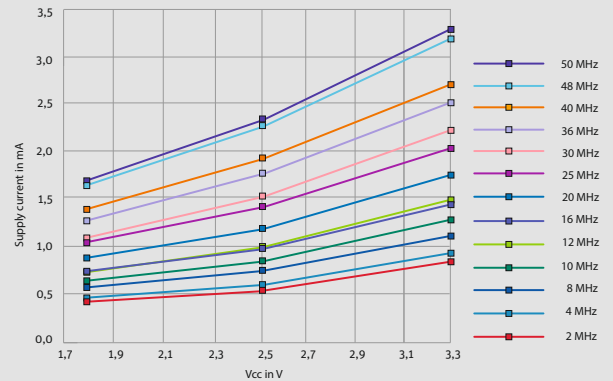

SUPPLY CURRENT VS.  $V_{CC}$  AT DIFFERENT FREQUENCIES;  $CL = 15$  PF

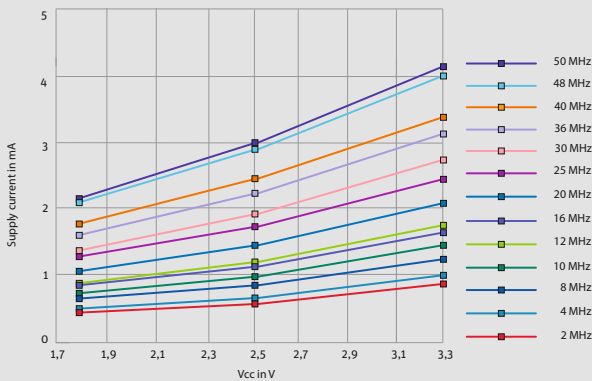

ENABLE / DISABLE FUNCTION

pin #1 (e/d control)	pin #3 (output)
open	active
high "1" ( $V_{IH} \geq 0.8 V_{DC}$ )	active
low "0" ( $V_{IL} \leq 0.2 V_{DC}$ )	high impedance

**stop function:**  
 • oscillator stops  
 • output high impedance

PACKAGING NOTE

- standard packing unit is 3000 pieces per reel
- customized quantities on request

TAPING SPECIFICATION

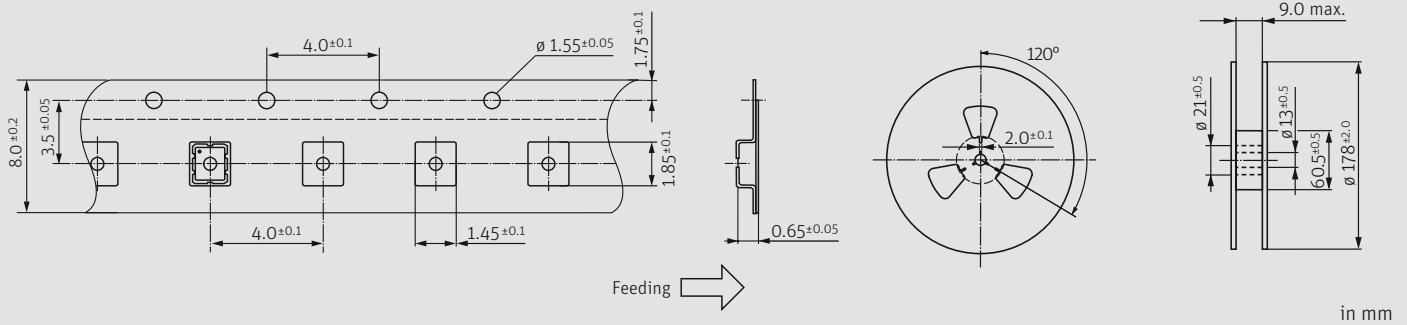

REFLOW SOLDERING PROFILE

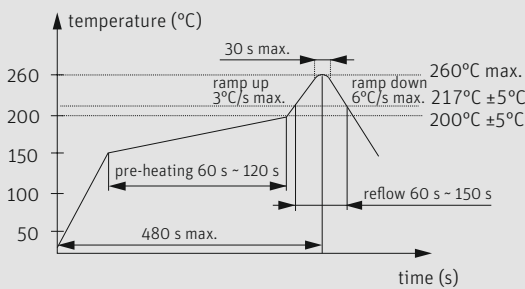

note: parts are also suitable for soldering systems with lead (Pb) content

MARKING

frequency  
 company / date code

date code: A ~ M: Jan. - Dec.

4: 2024 5: 2025 6: 2026 7: 2027 8: 2028 9: 2029

Jan.	Febr.	Mar.	Apr.	May	June
A	B	C	D	E	F
July	Aug.	Sept.	Oct.	Nov.	Dec.
G	H	J	K	L	M